

# wineART



Mode d'emploi

User manual

Bedienungsanleitung

Modo de empleo

# Contents

1 - Description	p.4
2 - Safety recommendations	p.5-6
3 - Protecting the environment and power saving	p.7
4 - Installing your appliance	p.8-9
• General points	
• The two keys to enjoying wine at its best	
5 - Commissioning your appliance	p.9-12
• Connection	
• Control panel	
• Brings your wine to the correct serving temperature	
• Preserving your opened bottles of wine at serving temperature	
• Putting on standby / Stopping the appliance	
6 - Everyday maintenance	p.12
7 - Operating anomalies	p.13-14
8 - Technical Specifications	p.15

# Description

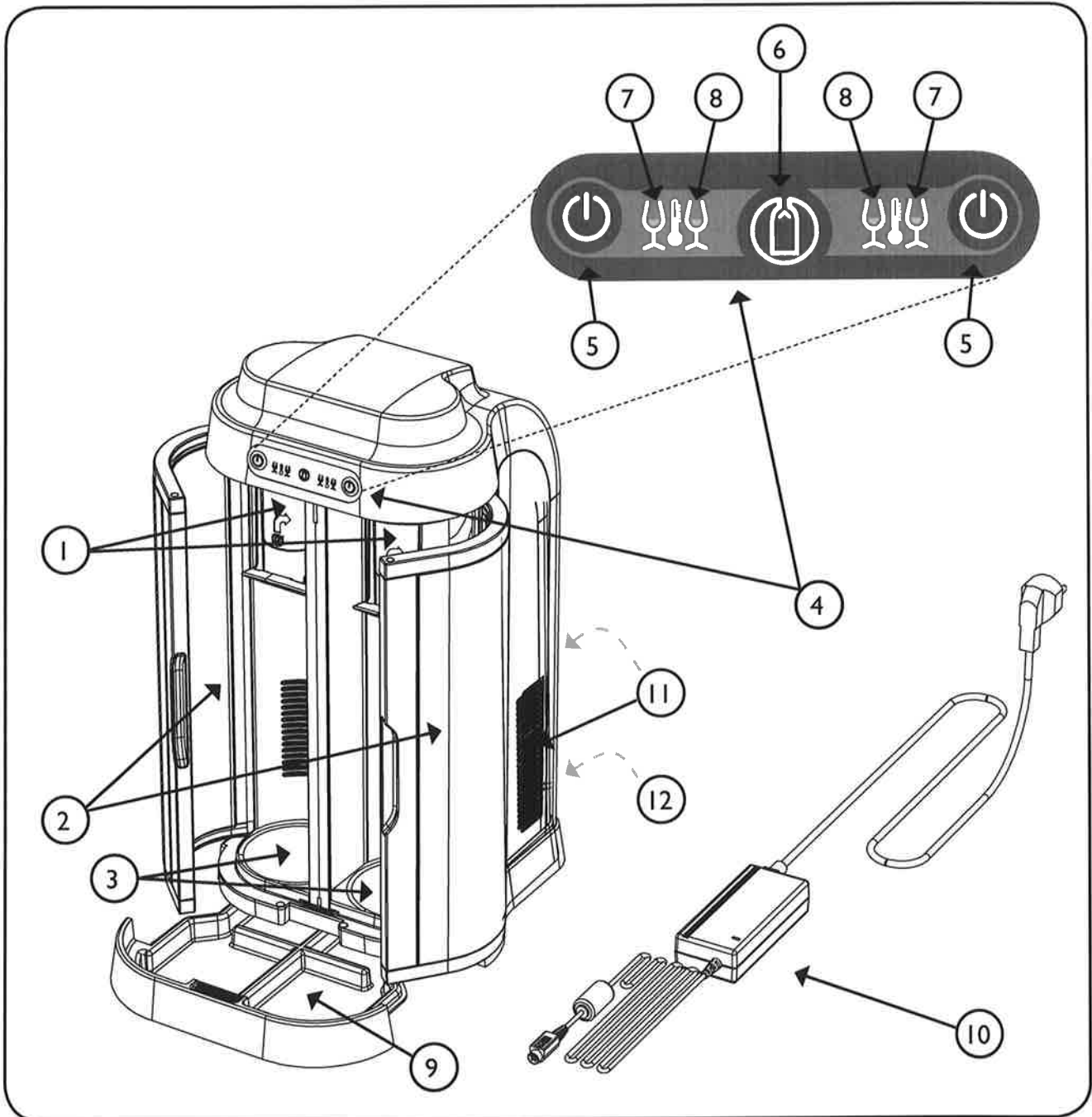

1- Vacuum sealing and serving temperature function elements  
 2- Doors  
 3- Temperate compartments  
 4- Control panel  
 5- Compartment temperature control and on/off switch: red wine or white/rosé wine  
 6- Oxygen extraction operating indicator light

7- Red indicator light = red wine mode  
 8- Yellow indicator light = white/rosé wine mode  
 9- Condensate collection tray  
 10- External mains transformer  
 11- Ventilation inlets on either side and at the back of the appliance  
 12- Power supply connection

# Safety Recommendations **2**

**Carefully read these operating instructions before using your appliance and store them for future reference.**

Using your appliance for purposes other than those specified in the operating instructions could damage it.

- Never use your appliance for anything other than its specific purpose, as described in these operating instructions.
  - Unplug your appliance when it is not being used for long periods of time.
  - Unplug your appliance before carrying out repair or maintenance work.
  - Unplug it by gently removing the plug from the socket and not by pulling on the power lead.
  - Never use a split power lead or one showing signs of wear along the length. A damaged lead should be immediately replaced. (Contact your retailer).
  - This product must only be used with the power supply unit provided by the manufacturer
  - Never leave children unsupervised around the appliance.
  - Check that the voltage of your electrical installation corresponds to that of the mains transformer supplied with the appliance.
  - Only use the mains transformer supplied with the appliance.
  - Your appliance is only designed for indoor use (ideal ambient temperature for operation is 18°C to 30°C\*).
  - If the power lead, plug or appliance appear to be damaged or do not function correctly, contact an authorised after-sales service.
  - Do not place the appliance, power lead or plug in water or any other liquid. Never fill the appliance with water or other liquids.
  - Do not allow the mains transformer's cable to hang over square corners and ensure that it is out of reach of children.
  - Do not place the appliance on a hot surface such as a hotplate, do not use it close to a source of heat (radiator, naked flame, window...).
- Do not let the power lead hang near to a source of heat.
- Place the appliance onto a flat, stable, non-flammable surface, at a suitable distance from sinks or taps, to avoid splashes from water or other liquids.
  - **Do not obstruct the ventilation inlets at the back and sides of the appliance. There must be a gap of at least 5cm between the ventilation inlets and walls or objects.**

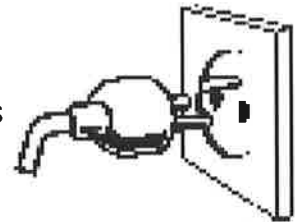

\*with a maximum ambient humidity level of 50%

## 2 Safety Recommendations

The manufacturer cannot be held responsible for any damage caused by improper use or incorrect handling of the appliance and the warranty shall not apply in such cases.

- This appliance is not designed to be used by persons (including children) with reduced physical, sensory or mental abilities, or by persons without experience or knowledge, except where they first receive instructions regarding use of the appliance or are supervised by somebody responsible for their safety.

## 3 Protecting the Environment and power saving

Recycling: a caring gesture

Electrical equipment has potentially harmful effects on the environment and human health owing to the presence of noxious substances.

You should therefore never trash electronic and electrical equipment with unsorted municipal waste. Speak to your retailer – s/he will explain all the collection resources available for disposing of your appliance when it reaches its end of life.



Disposal of packaging:

The packaging units used are made from recycled material.

After unpacking your appliance, retain your packaging, it will be required for any Customer Service requests or repairs. At the end of your appliance's useful life, take the packaging units to a waste disposal centre. For the most part, they will be recycled.

# Installing 4 your Appliance

## I – General points

Wine Art is designed for preserving and bringing still wine (white, rosé and red) to the correct serving temperature.

**The appliance cannot be used for fizzy wine (Champagne etc.).**

The compartments are designed to hold:

- 2 bottles of white or red wine/rosé;
- or** 1 bottle of red wine + 1 bottle of white/rosé wine;
- or** 1 single bottle,

whether these bottles are open (vacuum sealing) or closed (bringing wine to the correct serving temperature).



With Wine Art, your opened wine retains all of its flavours for up to 10 days.

**Please note: Wine Art holds standard 75 cl wine bottles (292 - 336 mm in height).** If your wine bottle is slightly smaller, you can increase the height of the bottle (for example by placing a coaster beneath it). Ensure that the bottle is correctly aligned.

## II – The 2 keys to enjoying wine at its best

### *1) Serve the wine at a suitable temperature:*

In order for wines to fully develop all their flavours, they must be served at the correct serving temperature. A wine stored at a temperature which is too high will have an overpowering alcohol content. On the contrary, a temperature which is too low will dull the wine's flavours and prevent them from fully developing.

The correct serving temperature for white/rosé wines is between 8°C and 10°C.

That of red wine is between 16°C and 18°C.

Wine Art respects your wine, which is why it brings wine to the correct serving temperature gradually.

# 4 Installing your Appliance

For example: a bottle of white/rosé wine taken from a wine cabinet at 12°C will require approximately 1 and a half hours to reach a suitable serving temperature (in the case of a full bottle at an ambient temperature of 20°C).

In the same conditions, a bottle of red wine will require approximately 3hrs to reach the correct serving temperature.

## 2) *Protect wine from oxygen once the bottle is opened:*

Wine breaths, it is made up of living elements which evolve. When it comes into contact with oxygen in the surrounding air, wine oxidises very rapidly.

Wine must be protected from any contact with oxygen in order to preserve its tasting qualities. The Wine Art oxygen extraction system preserves your wine by drawing oxygen from the bottle, protecting the wine from oxidation.

# 5 Commissioning your Appliance

## 1 – Connection

1) Remove the packaging as well as the protective elements inside and outside the appliance.

2) Check that the plug is to be connected to a power supply which is protected by the correct fuse size and functioning 30mA\* differential circuit breaker (\*not applicable to some countries).

Connect the mains transformer to the appliance at one end and to the mains plug at the other end in order to switch it on.

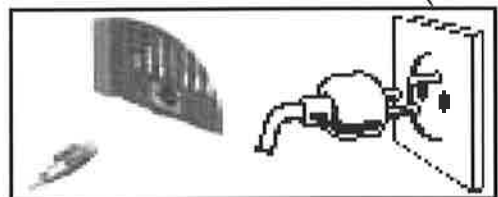

**NB:** observe the connection direction: arrow on the top.



# Commissioning your Appliance

# 5

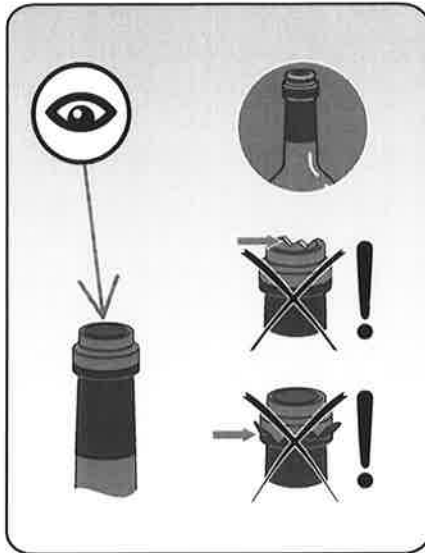
## Precautions before use



## II – The control panel

- The  keys are used for turning the compartments on and off and bringing wine to the correct temperature. They function independently (see III).
  - The  red temperature indicator lights indicate that the compartment is in red wine mode and the yellow indicator lights indicate that the compartment is in rosé/white wine mode.
  - The  indicator light in the centre concerns the air vacuum system. It is only a status light (see IV).
  - The two compartments function independently.
- > When selecting the temperature for the first time, the pump starts up automatically. The green indicator light flashes during the stabilization phase then stops flashing and remains on.

## III – Bringing your wine bottles to the correct serving temperature



Each compartment functions independently.

- Select a compartment.
- Raise the air vacuum system plunger until it is in the upper position then turn it to the right to lock it in the raised position. It is now in the correct position for bringing wine to the correct temperature without vacuum sealing. Place the bottle in the appliance ensuring



# 5 Commissioning your Appliance

that it is correctly aligned inside the compartment.

- Close the door.
- Press the  key (located above the compartment in use) as many times as required, until the  indicator light turns red for a bottle of red wine or yellow for a bottle of white/rosé wine. The appliance will emit a sound to let you know that it is functioning correctly.

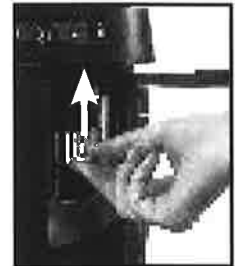

The serving temperature mode allows you to:

- bring a bottle of red wine taken from your chilled cabinet (12°C) to an ideal serving temperature (16-18°C) in approximately 3hrs,
- bring a bottle of white/rosé wine taken from your chilled cabinet (12°C) to an ideal serving temperature (8-10°C) in approximately 1 hr 30 mins.



For maximum ease of use, the serving temperatures are preset at the factory.

N.B.: When the bottle is no longer in the compartment, you can release the collar by turning it to the left and moving it down to the low position.

The appliance will emit a sound to let you know that it is functioning correctly.

To switch off the serving temperature mode, press the key of the compartment concerned as many times as necessary until the  indicator lights turn off.

## IV – Preserving your open bottles of wine at the correct serving temperature

### 1) PRESERVATION

This is achieved via an air vacuum device. The pump extracts the air inside the bottle, in this way protecting the wine from oxidation.

- Ensure that the air vacuum plunger is not in the raised position. If it is, turn the plunger to the left to release it and move it down to the low position.

The appliance will emit a sound to let you know that it is functioning correctly.

- Position the neck of the open (not empty) bottle under the air vacuum plunger and raise your bottle until it is in a vertical position.
- Close the door.- The air vacuum system then activates itself for a few seconds (the appliance then functions independently),

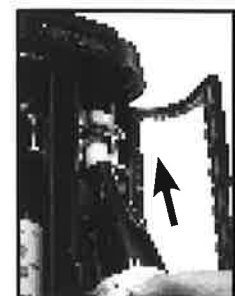

# Commissioning your Appliance **5**

The air vacuum system status light (🔆) lets you know that your wine is being stored in the best conditions when it stops flashing (green indicator light permanently on).

If the air vacuum system indicator light (🔆) is red, refer to chapter 7.

- Vacuum sealing a bottle repetitively can have an impact on the duration of preservation of wine.

- To remove the bottle from the appliance, open the compartment door then swivel the base of the bottle towards the outside of the compartment.

N.B.: The pump will activate itself again (which is normal) for approximately 10 seconds.

Note: Do not insert corks or any other elements that may obstruct the bottle neck, it must be completely clear. Ensure that the bottle is correctly aligned inside the compartment (see chapter 5-1 Precautions to observe)

## 2) BRINGING YOUR WINE TO THE CORRECT TEMPERATURE

- To then bring your open bottle to an ideal serving temperature, select the wine mode corresponding to your bottle by pressing the (🔆) button of the compartment concerned as many times as necessary. The (🔆) red indicator light indicates that the compartment is in red wine mode. The (🔆) yellow indicator light indicates that the compartment is in white or rosé wine mode. When no indicator light is on, the compartment's serving temperature mode is not functioning.

Note: the compartment is still in serving temperature mode. To switch off this mode, press the (🔆) key of the compartment concerned as many times as necessary until the (🔆) indicator lights turn off.

## V – Turning off the appliance / Placing the appliance on standby

Before unplugging your appliance, ensure that the serving temperature mode is not activated (red and yellow indicator lights off).

If it is activated, press the (🔆) keys several times until all the indicator lights on the control panel turn off.

Then, to turn off the appliance, simply unplug the mains plug then pull towards you the mobile section of the power lead identified by the arrow on the top of the plug. Do not use force.

Note: to place the appliance on standby, press the (🔆) keys of the two compartments several times, until the temperature indicator lights go off.



# 6 Everyday Maintenance

Whenever carrying out maintenance, first unplug the appliance and refer to chapter V.

Clean the inside and outside of the appliance using a soft damp cloth.

Always use gentle cleaning products and never pour water onto the product.

As part of normal operation, and according to weather conditions (temperature/humidity), the appliance, by producing cold, may produce natural condensation. This condensation residue is collected in the specially designed drawer in the base of the appliance.

Regularly check the condensation water level.

To empty the condensation water:

- open the 2 doors
- gently pull the drawer towards you to release it
- once you have emptied and cleaned the drawer, replace it by pushing it horizontally into the slot provided.

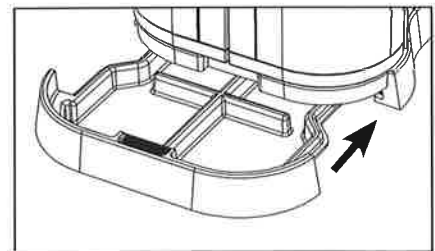

Vacuuming the rear fan:

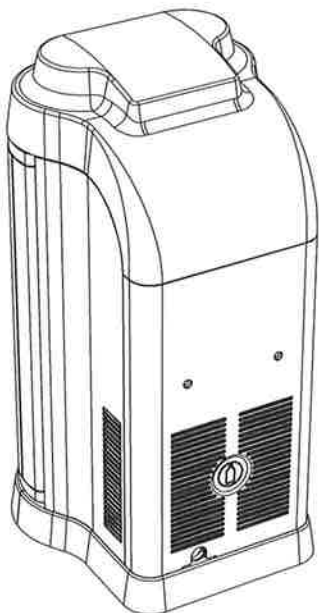

**Recommended  
twice a year.**

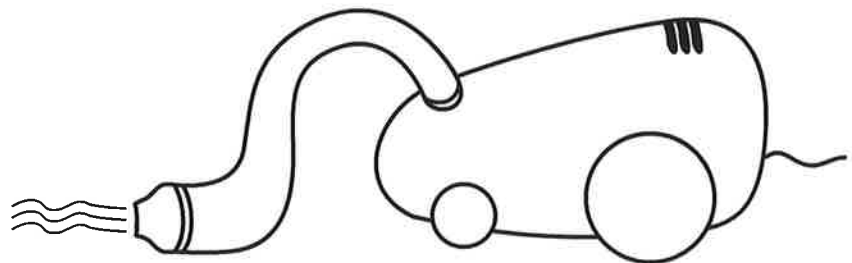

# Operating Anomalies

# 7

## ? The air vacuum system red status light is flashing red.

> *Air vacuum system fault alarm.*

- **the bottle may be incorrectly positioned:** align the bottle correctly inside the compartment then restart the white/rosé wine or red wine mode by pressing the  button.

- **the bottle neck is blocked (by a cork or other object):**

Remove any object that is blocking the bottle neck, then place the bottle in the compartment, and restart the operation. Restart the white/rosé wine or red wine mode by pressing the  button.

- **the plunger is in the raised position:**

Move it down to the bottle neck. Restart the white/rosé wine or red wine mode by pressing the  button.

## ? The yellow and red temperature programming indicator lights are both on at the same time.

> *Temperature sensor fault alarm.*

The temperature sensor is faulty: **unplug the appliance** and contact an authorized after-sales service.

## ? The bottle of white/rosé wine is not sufficiently chilled.

> *The serving temperature function has not worked correctly.*

- **the appliance is not correctly supplied with power:** check that the appliance is correctly connected to its power supply and the mains plug.

- **the wrong control was used when setting the compartment:** check that the indicator light of the compartment concerned indicates white/rosé wine mode on the control panel (yellow indicator light on, above the compartment).

- **not enough time was allowed to bring the bottle to the correct temperature:** when a bottle of white/rosé wine is at an ambient temperature, the appliance requires approximately 3 hours to gradually bring the wine to the correct serving temperature.

- **the ambient temperature surrounding the appliance is above 30°C. In these conditions, it is impossible to make your bottle of white/rosé wine any colder.**

# 7 Operating Anomalies

**- the ventilation inlets are blocked (by an object or wall).**

It is necessary to create sufficient space around the appliance and ensure that the ventilation inlets are not blocked. (Min. 5 cm)

**? The air vacuum plunger remains in the upper position.**

> *Plunger in raised position.*

Check that the plunger is not in the serving temperature mode position (locked in the slot on the right). If it is, turn it to the left to release it and move it downwards. Otherwise, apply light pressure to the top of the lever.

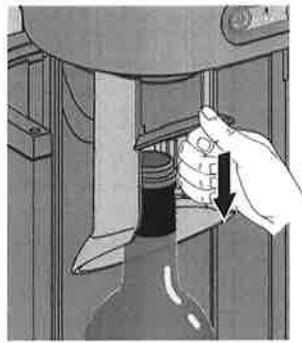

**? Water is appearing at the back of the appliance.**

> *The condensation water drawer is full.*

Open the 2 doors. Gently pull the drawer towards you to release it. Once you have emptied and cleaned the drawer, replace it by pushing it horizontally into the slot provided under the product.

# Technical Specifications **8**

## - Size :

	Unpackaged
Height (mm)	478
Width (mm)	245
Depth (mm)	248
Weight (kg)	5,48

- Red wine serving temperature: 16/18°C
- Rosé and white wine serving temperature: 8/10°C
- External mains transformer AC 100-240V (according to the country) - 50/60Hz - 2.5 A - Class II
- Power input: 70 W
- Operating ambient temperature: 18°C - 30°C (at 30°C, the maximum ambient humidity level is 50%)
- Length of time opened bottles can be stored: up to 10 days maximum\*
- Oxygen extraction: vacuum pressure of 300 mbars minimum
- Wine bottles that can be used in the appliance: 292 - 336 mm in height.

The SN climate class specified on the product information plate only relates to electrical safety international standards applicable to the product:

Standards            IEC 60335-1 : 2010  
                              IEC 60335-2-24 : 2010

\*according to the wine and its vintage.